

Switching (30V, 3.5A)

RDS035L03

●Features

- 1) Low Qg.
- 2) Low on-resistance.
- 3) Excellent resistance to damage from static electricity.

●Application

Switching

●Structure

Silicon N-channel
MOS FET

●External dimensions (Units : mm)

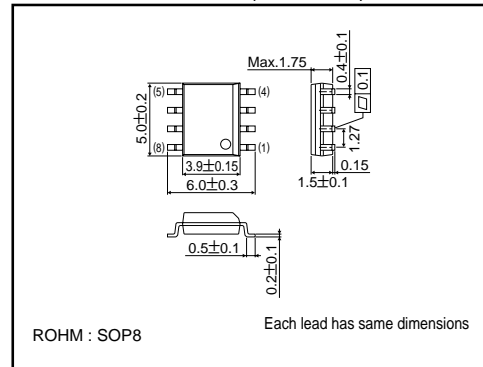

●Equivalent circuit

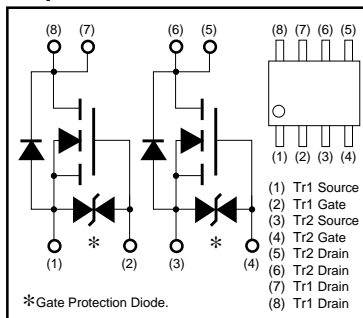

* A protection diode is included between the gate and the source terminals to protect the diode against static electricity when the product is in use. Use a protection circuit when the fixed voltage are exceeded.

●Absolute maximum ratings (Ta=25°C)

Parameter	Symbol	Limits	Unit	
Drain-Source Voltage	V_{DSS}	30	V	
Gate-Source Voltage	V_{GSS}	±20	V	
Drain Current	Continuous	I_D	3.5	A
	Pulsed	I_{DP}^*	14	A
Reverse Drain Current	Continuous	I_{DR}	3.5	A
	Pulsed	I_{DRP}^*	14	A
Source Current (Body Diode)	Continuous	I_S	1.3	A
	Pulsed	I_{SP}^*	5.2	A
Total Power Dissipation (Tc=25°C)	P_D	2	W	
Channel Temperature	Tch	150	°C	
Storage Temperature	Tstg	-55~+150	°C	

* $P_w \leq 10\text{ms}$, Duty cycle $\leq 1\%$

Transistors

● Thermal resistance (Ta=25°C)

Parameter	Symbol	Limits	Unit
Channel to Ambient	Rth(ch-A)	62.5	°C / W

● Electrical characteristics (Ta=25°C)

Parameter	Symbol	Min.	Typ.	Max.	Unit	Test Conditions
Gate-Source Leakage	I _{GSS}	–	–	±10	μA	V _{GS} =±20V, V _{DS} =0V
Drain-Source Breakdown Voltage	V _{(BR)DSS}	30	–	–	V	I _D =1mA, V _{GS} =0V
Zero Gate Voltage Drain Current	I _{DSS}	–	–	10	μA	V _{DS} =30V, V _{GS} =0V
Gate Threshold Voltage	V _{GS(th)}	1.0	–	2.5	V	V _{DS} =10V, I _D =1mA
Static Drain-Source On-State Resistance	R _{DS(on)}	–	62	80	mΩ	I _D =3.5A, V _{GS} =10V
		–	105	134		I _D =3.5A, V _{GS} =4.5V
		–	132	172		I _D =3.5A, V _{GS} =4V
Forward Transfer Admittance	Y _{fs} *	2.5	–	–	S	I _D =3.5A, V _{DS} =10V
Input Capacitance	C _{iss}	–	180	–	pF	V _{DS} =10V
Output Capacitance	C _{oss}	–	95	–	pF	V _{GS} =0V
Reverse Transfer Capacitance	C _{rss}	–	38	–	pF	f=1MHz
Turn-On Delay Time	t _{d(on)} *	–	6	–	ns	I _D =2A, V _{DD} =15V
Rise Time	t _r *	–	12	–	ns	V _{GS} =10V
Turn-Off Delay Time	t _{d(off)} *	–	20	–	ns	R _L =7.5Ω
Fall Time	t _f *	–	6	–	ns	R _{GS} =10Ω
Total Gate Charge	Q _g *	–	6.5	–	nC	V _{DD} =15V
Gate-Source Charge	Q _{gs} *	–	1.2	–	nC	V _{GS} =10V
Gate-Drain Charge	Q _{gd} *	–	1.8	–	nC	I _D =3.5A

* Pulsed

● Body diode characteristics (Source-Drain Characteristics) (Ta=25°C)

Parameter	Symbol	Min.	Typ.	Max.	Unit	Test Conditions
Forward Voltage	V _{SD} *	–	–	1.5	V	I _S =3.5A, V _{GS} =0V
Reverse Recovery Time	t _{rr} *	–	26	–	ns	I _{DR} =3.5A, V _{GS} =0V
Reverse Recovery Charge	Q _{rr} *	–	24	–	nC	di/dt=50A/μs

* Pulsed

Transistors

●Electrical characteristic curves

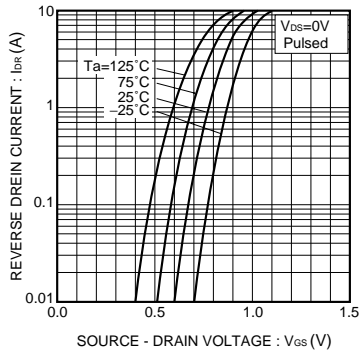

Fig.1 Reverse Drain Current vs. Source - Drain Voltage

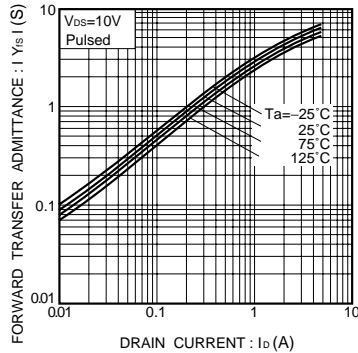

Fig.2 Forward Transfer Admittance vs. Drain Current

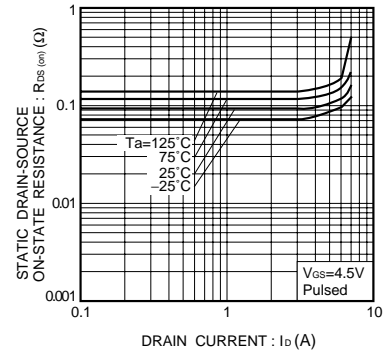

Fig.3 Static Drain-Source On-State Resistance vs. Drain Current (I)

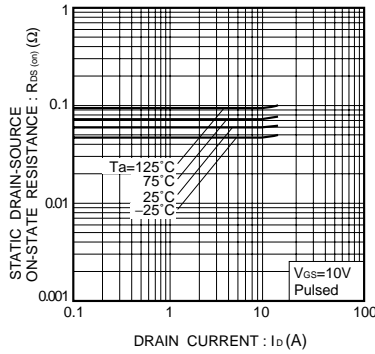

Fig.4 Static Drain-Source On-State Resistance vs. Drain Current (II)

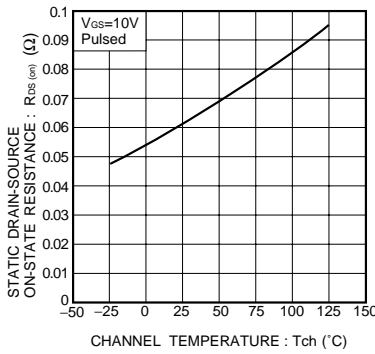

Fig.5 Static Drain-Source On-State Resistance vs. Channel Temperature

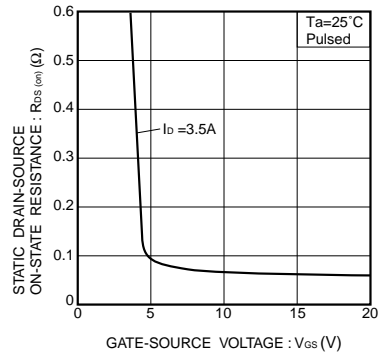

Fig.6 Static Drain-Source On-State Resistance vs. Gate-Source Voltage

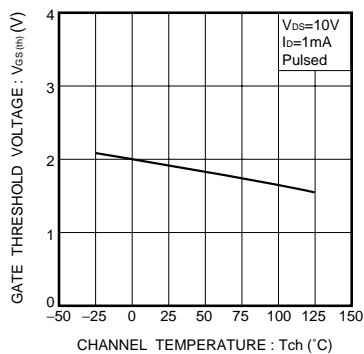

Fig.7 Gate Threshold Voltage vs. Channel Temperature

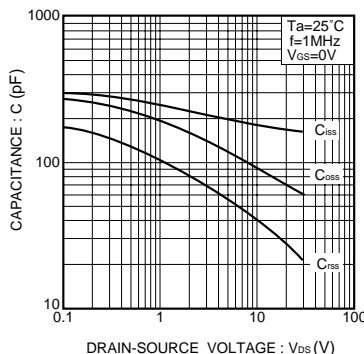

Fig.8 Typical Capacitance vs. Drain-Source Voltage

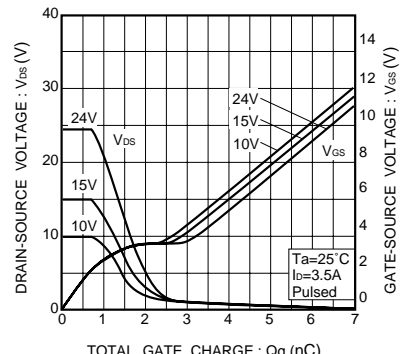

Fig.9 Dynamic Input Characteristics

Transistors

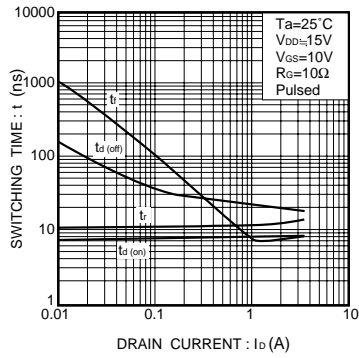

Fig.10 Switching Characteristics

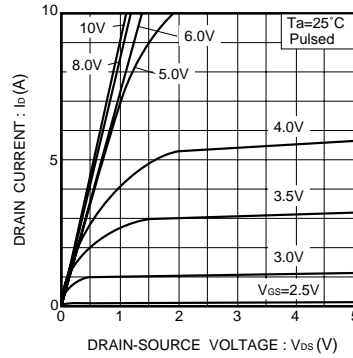

Fig.11 Typical Output Characteristics

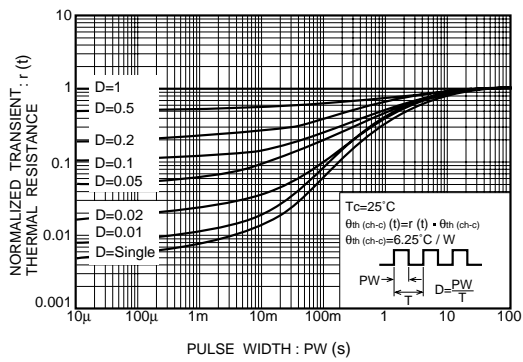

Fig.12 Normalized Transient Thermal Resistance vs. Pulse Width